

## ARIETE SM S/57 S/57SF S/108 S/108SF S

Attacchi in alluminio per le applicazioni a vite  
 Aluminium fittings for screw-on applications  
 Aluminium anschlüsse für Anwendungen mit Schraube  
 Aluminium éléments de fixation pour les applications à vis  
 Aluminium sujeciones para aplicaciones mediante tornillo

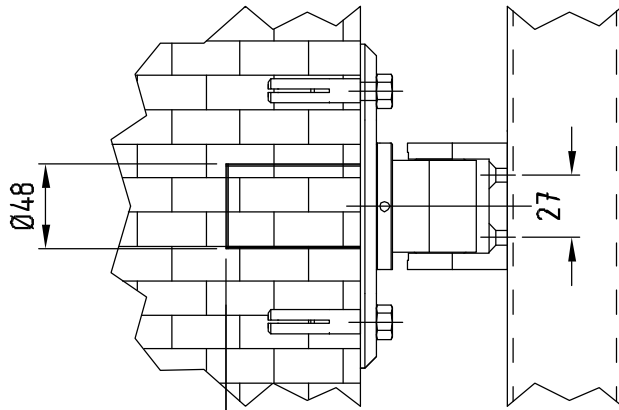

Ariete 108	minimo	70	64
Ariete 57 e SM	minimo	30	64

### 6026-01

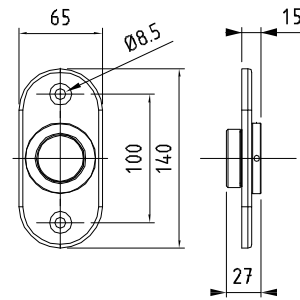

### 6026-02

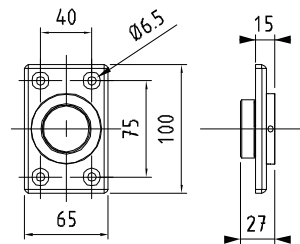

### 6026-04

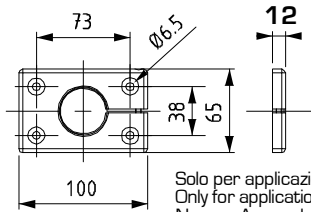

Solo per applicazione con Ariete 57 S/57SF S singola  
 Only for application with single Ariete 57 S/57SF S  
 Nur zur Anwendung mit Ariete 57 S/57SF S Einzelement  
 Pour application avec Ariete 57 S/57SF S simple seulement  
 Sólo para aplicación con Ariete 57 S/57SF S simple

### 6026-03

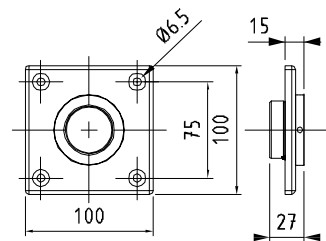

## ARIETE SM W/57 W/57SF W/108 W/108SF W

Attacchi in ferro per le applicazioni a saldare  
 Iron fittings for weld applications  
 Iron anschlüsse für Anwendungen mit Schweißung  
 Fer éléments de fixation pour les applications à souder  
 Hierro sujeciones para aplicaciones mediante soldadura

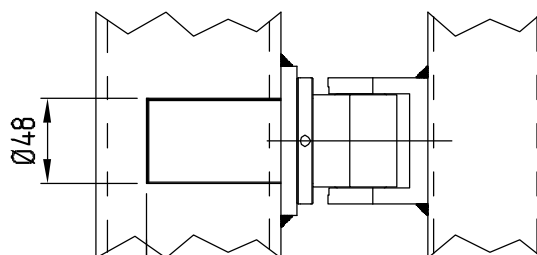

Ariete 108	minimo	70	64
Ariete 57 e SM	minimo	30	64

### 0510-01

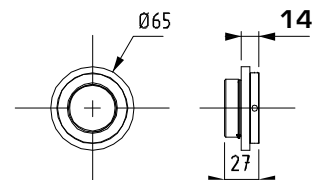

### 0510-02

